

ENG

USER MANUAL

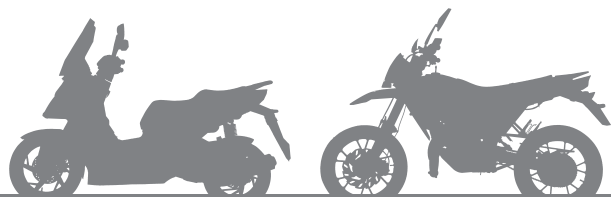

mod.# D01 - EU4

EG 168/2013

INTRODUCTION

Thanks for your purchasing of this vehicle. This model is designed for safety, built for durability, and perfected for daily street use. The unique vehicle design, enrich of stylish and peronality, represents your outstanding taste and favor to pursue the state of the art living attitude.

This manual describes the correct usage of this motorcycle including safety riding, simple inspection methods and so on. For a more comfortable and safety riding, please read this manual carefully. If any questions concerning the operation or maintenance of your vehicle, please consult a dealer.

IMPORTANT MANUAL INFORMATION

In this manual with some important information is distinguished by the following notations:

WARNING

It is **WARNING** instructions that need to follow, failure of follow could be end in result severe injury or lead to death to the operator.

CAUTION

A **CAUTION** indicates with special precautions to avoid damage to the vehicle.

CAUTION

- Please always put this manual with vehicle for rider maintenance/ dealer tracking of service records even if vehicle is being sold.
- This manual contains the most of the vehicle information, however, the maker will continually improve it's product design and quality that lead to difference between the manual and vehicle . If you have any questions concerning this manual, please consult your dealer.

WARNING

FOR YOUR OWN SAFETY, PLEASE READ THIS MANUAL CAREFULLY BEFORE OPERATION THIS VEHICLE. ONLY OPERATE THE VEHICLE UNTIL YOU HAVE COMPLETELY AWARE OF ADEQUATE KNOWLEDGE OF CONTROLS AND OPERATION FEATURE AND YOU HAVE BEEN TRAINED IN SAFE AND PROPER RIDING TECHNIQUES. PERIODIC INSPECTIONS, WELL MAINTENANCE AND GOOD RIDING SKILLS, WILL ENSURE YOUR SAFETY RIDING AND INCREASE THE PRODUCT RELIABILITY OF THIS VEHICLE.

*Product and specifications are subject to change without notice.

IMPORTANT MANUAL INFORMATION

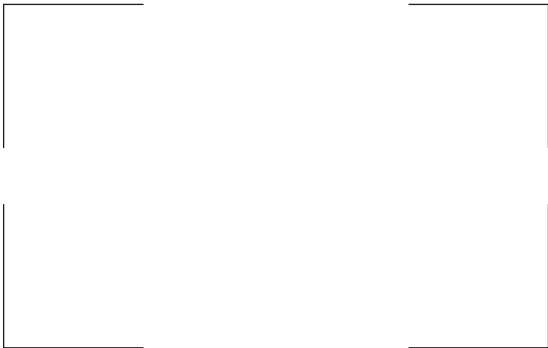

Dealer label here

TABLE OF CONTENTS

INTRODUCTION	1	Seat.....	21	play.....	36
IMPORTANT MANUAL INFORMATION	2	Owner's tool kit.....	22	Brake pads.....	37
TABLE OF CONTENTS	4	Side stand.....	22	Brake fluid.....	37
SAFETY INFORMATION	5	PRE-OPERATION CHECKS	23	Cables.....	38
Other safe-riding points.....	7	Pre-operation check list.....	24	Throttle grip and cable.....	38
DESCRIPTION OF THE VEHICLE	8	OPERATION AND IMPORTANT RIDING POINTS	25	Lubricating the front and rear brake.....	38
Left view.....	8	Starting the engine.....	25	Front fork.....	39
Right view.....	9	Starting off.....	26	Steering.....	39
Controls and instruments.....	10	Shifting and riding.....	26	Wheel bearings.....	40
CONSUMER INFORMATION	11	Acceleration and deceleration.....	26	Drive chain.....	40
Vehicle identification number (VIN).....	11	Braking.....	27	Shock absorber.....	40
INSTRUMENT AND CONTROL FUNCTIONS	12	Parking.....	27	Battery.....	41
Main switch / steering lock.....	12	Stop the Engine.....	27	Fuse.....	42
Dashboard unit - Analog.....	12	Engine break in.....	27	Lighting - Option 1.....	42
Dashboard unit - Digital.....	13	PERIODIC MAINTENANCE AND MINOR REPAIR	29	Lighting - Option 2.....	44
Handlebar switches - left.....	16	Owner's tool kit.....	30	TROUBLESHOOTING	46
Handlebar switches - right.....	17	Spark plug.....	30	Troubleshooting chart.....	47
Kickstarter.....	17	Final transmission oil.....	31	CLEAN AND STORAGE	48
Brake lever.....	17	Coolant.....	32	Clean the vehicle.....	48
Brake pedal.....	18	Air filter.....	32	Storage.....	49
Clutch pedal.....	18	Carburetor.....	33	SPECIFICATIONS	50
Fuel cock.....	18	Idling speed.....	33	WARRANTY INFORMATION	52
Fuel tank cap.....	19	Throttle cable free play.....	33	MAINTENANCE SCHEDULE	53
Fuel.....	19	Clutch lever free play.....	34	SERVICE PLAN	54
Oil tank cap.....	20	Tires.....	34	SPACE FOR NOTES	55
Radiator and coolant reservoir.....	20	Rims.....	36		
Catalytic converter.....	21	Brake lever free play / Brake pedal free			

SAFETY INFORMATION

THIS VEHICLE ARE TWO WHEEL SINGLE TRACK VEHICLES. THE USE OF SAVETY AND OPERATION MAY IN DIFFERENT RESULT BY THE USE OF PROPER RIDING TECHNIQUES OF THE OPERATOR. TO REMIND OF OPERATOR, WHO SHOULD KNOW THE FOLLOWING REQUIREMENTS BEFORE RIDING.

HE OR SHE SHOULD:

- WELL TRAINED AND FIMILIAR TO ALL THE ASPECTS OF Vehicle OPERATION.
- FULLY READ AND AWARE OF MAINTENANCE REQUIREMENTS THAT NOTED IN THIS OWNER'S MANUAL.
- OBTAIN QUALIFIED TRAINING & LEGAL LICENSE FOR OPERATION OF THIS VEHICLE.
- WELL AND PROFESSIONAL MAINTENANCE SERVICE FOR OPERATOR AND CERTIFICATED REPAIR SHOP/DEALER TO ACQUIRE GOOD MECHANICAL CONDITIONS OF VEHICLE.

Safe riding

- Always pre-check your vehicle before riding is key point to prevent an accident.
- Please follow the maxium loads limited of operator and passenger.
- Most of accident on the motorists is cased by automobile driver who "failure to recognize out the vehicle" and caused mobile/vehicle accidents. Therefore, to make yourself conspicuous appear to public will be very effective in reducing the change of this kind of accidents.

Therefore:

- Wear a brightly colored and protective clothes/Jacket
- Operate the turning signals before turning and slow down the Speed when approaching and passthrough the intersection
- Keep proper distance with other Motorists, and let them aware of your location
- Know your skills and limits.

- Never lend your vehicle to oththers who not qualified for riding
- Always follow the legal speed limit on the vehicle and traffic law
- The posture of the operator and passenger is important for proper control. properly riding posture can Keep vehicle in balance while riding.
 - Operator should sit up-right with two hand hold on handle bar, foot on floorboard while driving.
 - Passenger should make sure that he/she can firmly hold on grip or operator with foot step on footrest.
- Drving after Acohol drink or other illegal drugs is strickly prohibited.
- This vehicle is designed for onroad use only. It is not suitable for off-road use.

Protective clothing

Properly clothing yourself will keep you safety from potential accidents:

- Always wear an approved helmet.
- With face shield to protect your eye from dust and rain drop.

SAFETY INFORMATION

- The wear of proper jacket, shoes, groves etc., can be better protection, reducing the degree of injury from un-expected accident.
- Never wear loose-fitting clothes, otherwise they could catch on the control levers or wheels and cause injury or an accident.
- Never touch the engine or exhaust system during or after operation. They become very hot and can cause burns. Always wear protective clothing that covers your legs, ankles, and feet.

Modifications

Modifications made to this vehicle that not approved by maker, or the removal of original equipment, may let vehicle unsafe for use and cause severe personal injury. Modifications may also make your vehicle illegal touse.

Loading and accessories

Adding accessories or cargo to your vehicle may cause the different on the weight distribution of vehicle and in-

fluence on the steering & balance. It may cause possibility of an accident, please extremely caution and follow below limitation when you equipped with accessories. Below are some general or accessories. Here are some guidelines to follow if loading cargo or adding accessories to your vehicle.

Loading

The total weight of the operator, passenger, accessories and cargo must not exceed the maximum load limit.

**Maximum load
(not include the vehicle): 150kg**

When loading within this weight limit, keep the following in mind:

- Cargo and accessory weight should be kept as low and close to the vehicle as possible. Make sure to distribute the weight as evenly as possible on both sides of the vehicle to minimize imbalance or instability.

- Make sure that accessories and cargo are securely attached to vehicle before riding
- Never attach any large or heavy items to the handlebar, front fork, or front fender. Such items can create unstable handling or a slow steering response.

Accessories

Genuine accessories have been specifically designed for use on this vehicle. If need, please contact with dealer for detail. Since the maker can not test all other accessories , you must personally be responsible for the proper selection, installation and use of non-OEM accessories.

Keep the following guidelines in mind, when mounting accessories.

- Never install accessories or carry cargo that would influence on the ground clearance, limit suspension travel, steering, or obscure lights or turning lights, reflectors.

SAFETY INFORMATION

- Accessories on the handle bar/front suspension area will cause bad influence on steering the vehicle. If you will install accessories, please keep it as light in weight and not interfere on steering the vehicle. This vehicle is for On-Road transportation purpose only, please do not install any of extended cargo carrier as sulky, that will make vehicle unstable in cross winds and vehicle turns.
 - While equip with electrical accessories, please consult with qualified stores, to make sure such items will not exceed the capacity of the vehicle's electrical system. Unproper install of such items may cause a dangerous loss of lights, lower engine power or even damage the vehicle.
- Gasoline and exhaust gas**
- **GASOLINE IS HIGHLY FLAMMABLE:**
 - Always turn the engine off when refueling.
 - Take care not to spill any gasoline on the engine (hot) or exhaust system when refueling.
 - Do not smoke or use Mobile phone while re-fueling.
 - Never start the engine or let it run for any length of time in a closed area. The exhaust fumes are poisonous and may cause loss of consciousness and death within a short time.
 - Always turn the engine off before leaving the vehicle and remove the key from the main switch. When parking the vehicle, please note the following:
 - The engine and exhaust system remain hot, therefore, park the vehicle in a place where pedestrians or children are not likely to touch these hot areas.
 - Do not park the vehicle on a slope or soft ground, otherwise it may fall over.
 - Do not lay your vehicle to near flammable place.
 - In case of swallow any gasoline, or gasoline get into your eyes, please see your doctor immediately. Keep away the gasoline to your skin and water.

OTHER SAFE-RIDING POINTS

- Turn the signal before making turns.
- When raining or across on run on the wet road, Iron Plates, keep your speed low, slightly using braking to avoid slipping or even fall down.
- Be careful when passing parked cars. A driver might not see you and open a door in your path.

DESCRIPTION OF THE VEHICLE

LEFT VIEW

1. Front wheel
2. Front disc brake
3. Headlight
4. Front turn signal light
5. Radiator
6. Fuel tank cap
7. Spark plug
8. Fuel cock
9. Side stand
10. Air filter
11. Pedal
12. Seat lock

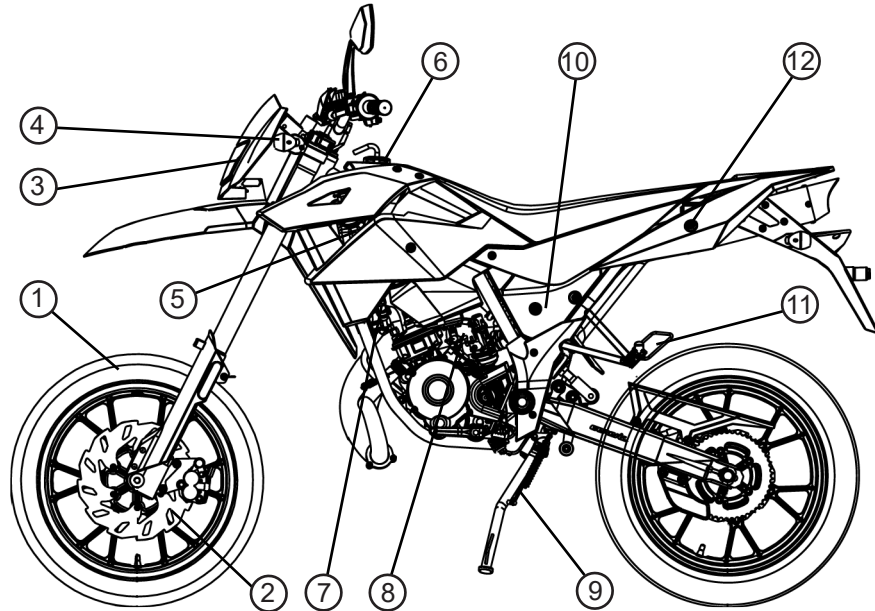

DESCRIPTION OF THE VEHICLE

RIGHT VIEW

- 13. License plate light
- 14. Tail light / brake light
- 15. Rear wheel
- 16. Muffler
- 17. Rear turn signal light
- 18. Rear disc brake
- 19. Kickstarter
- 20. Brake pedal
- 21. Coolant reservoir
- 22. Brake lever

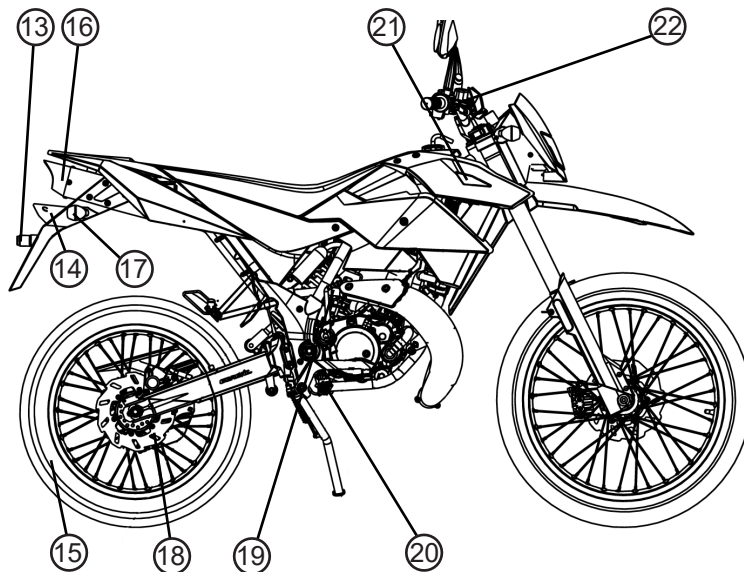

DESCRIPTION OF THE VEHICLE

CONTROLS AND INSTRUMENTS

- 23. Clutch lever
- 24. Left handlebar switches
- 25. Clutch pedal
- 26. Dashboard unit
- 27. Main switch
- 28. Brake pedal
- 29. Brake lever
- 30. Throttle grip
- 31. Right handlebar switches

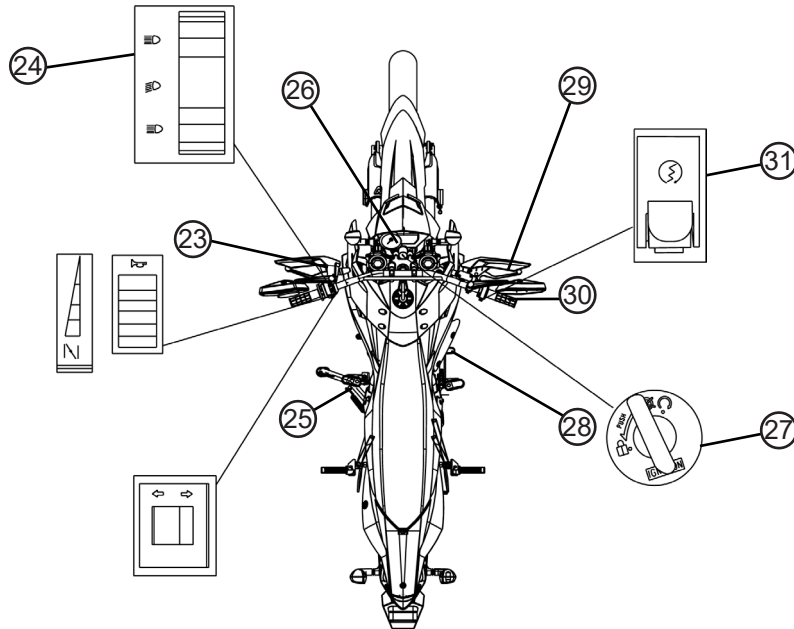

CONSUMER INFORMATION

VEHICLE IDENTIFICATION NUMBER (VIN)

Please write down the VIN (vehicle identification number) to order replacement parts from your dealer or the vehicle should be stolen.

The vehicle identification number of the vehicle (1) is stamped on the steering head.

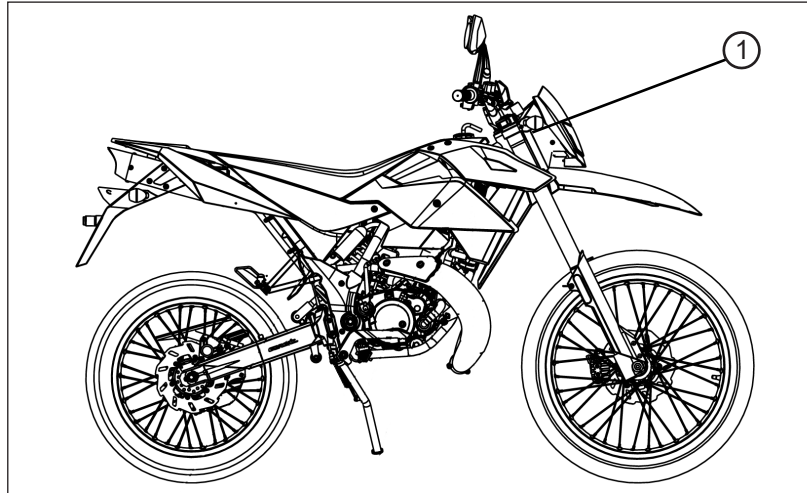

CAUTION

The vehicle identification number is used to identify your motorcycle and may be used to register your vehicle with the licensing authority in your area.

INSTRUMENT AND CONTROL FUNCTIONS

MAIN SWITCH / STEERING LOCK

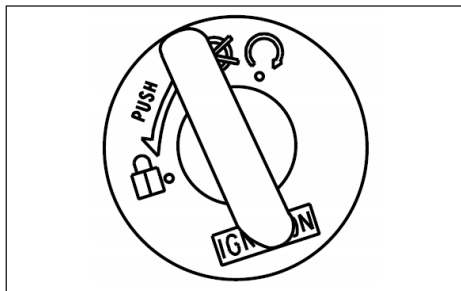

The main switch/steering lock controls the ignition and lighting systems, and also used to lock the steering. The various positions are described as below.

On

All electrical circuits are supplied with power, the engine can be started. The key cannot be removed.

Off

All electrical systems are off. The key can be removed.

Steering lock

The steering is locked, and all electrical systems are off. The key can be removed.

Lock the steering

1. Turn the handlebars all the way to the left.
2. Push the key in and turn it to the
3. Remove the key.

Unlock the steering

Push the key in and then turn it to

⚠ WARNING

Never turn the key to or , while the vehicle is moving, otherwise the electrical systems will be switched off, which may result in loss of control or an accident. Make sure that the vehicle is stopped before turning the key.

DASHBOARD UNIT - ANALOG

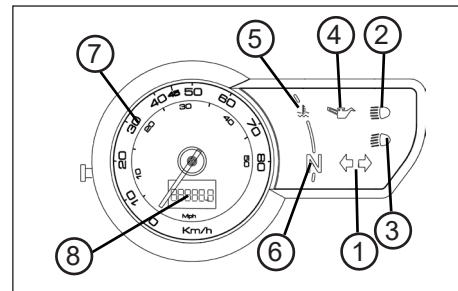

1. Turn signal indicator lamp
2. Main beam indicator lamp
3. Low beam indicator lamp
4. 2-stroke engine oil indicator
5. Coolant indicator light
6. Neutral indicator lamp N
7. Speedometer
8. Odometer

Turn signal indicator lamps

The relevant indicator lamp flashes whenever you activate the turn signals.

INSTRUMENT AND CONTROL FUNCTIONS

Main beam indicator lamp

Lights up whenever main beam is switched on.

Low beam indicator lamp

Low beam indicator comes on when low beam headlight is on.

2-stroke engine oil indicator

The warning light when the engine oil level in the 2-stroke engine oil tank is low. If the warning light comes on during operation, check the oil level and fill the oil tank with an 2- stroke engine oil. The warning light should go off after the 2-stroke engine oil tank has been refilled.

CAUTION

Do not operate the vehicle until you know that the 2-stroke engine oil level is sufficient. Lack of engine oil will damage the engine.

⚠ WARNING

Please note that the engine oil warning light is model dependent. If your vehicle has no engine oil warning you must check the oil level before each ride.

Water thermometer indicator

It indicates the cooling fluid temperature. When it is on, means the water temperature is too high and should have a break sometime. If it is on by a long time, please check the coolant bottle.

Neutral indicator lamp (N)





Lights up whenever neutral (N) is selected.

Speedometer and odometer

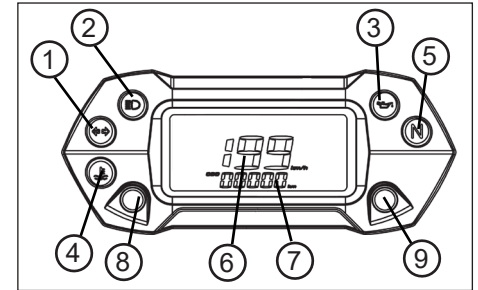
The dashboard unit is equipped with a speedometer and an odometer. The speedometer shows the riding speed. The odometer shows the total distance traveled.

DASHBOARD UNIT - DIGITAL



1. Turn signal indicator lamp 
2. Main beam indicator lamp 
3. 2-stroke engine oil indicator 
4. Coolant indicator light 
5. Neutral indicator lamp N
6. Speedometer
7. Odometer
8. SEL - button
9. ADJ - button

Turn signal indicator lamps

The relevant indicator lamp flashes whenever you activate the turn signals.

INSTRUMENT AND CONTROL FUNCTIONS

Main beam indicator lamp

Lights up whenever main beam is switched on.

2-stroke engine oil indicator

The warning light when the engine oil level in the 2-stroke engine oil tank is low. If the warning light comes on during operation, check the oil level and fill the oil tank with an 2- stroke engine oil. The warning light should go off after the 2-stroke engine oil tank has been refilled.

CAUTION

Do not operate the vehicle until you know that the 2-stroke engine oil level is sufficient. Lack of engine oil will damage the engine.

⚠ WARNING

Please note that the engine oil warning light is model dependent. If your vehicle has no engine oil warning you must check the oil level before each ride.

Water thermometer indicator

It indicates the cooling fluid temperature. When it is on, means the water temperature is too high and should have a break sometime. If it is on by a long time, please check the coolant bottle.

Neutral indicator lamp (N)

Lights up whenever neutral (N) is selected.

Speedometer and odometer

The dashboard unit is equipped with a speedometer and an odometer. The speedometer shows the riding speed. The odometer shows the total distance traveled.

Adjust button

Main screen

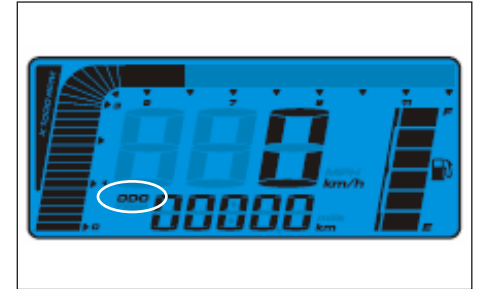

In the main screen press the adjust button once to switch the function from odometer to trip.

When the odometer display range is over the Max it starts at zero. When the display range of trip meter is over the Max it will also start at zero automatically but it can also be reset manually by holding the adjust button for 3 sec under the trip screen.

In the main screen press and hold the adjust button for 3 sec to switch from km to mile.

INSTRUMENT AND CONTROL FUNCTIONS

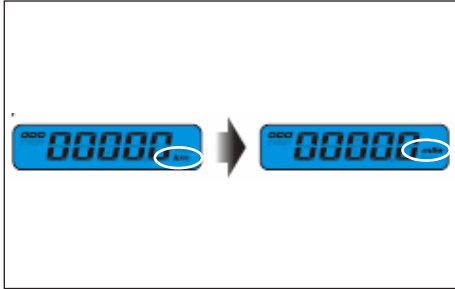

Trip screen



In trip screen press the adjust button once to switch from trip to clock. Press and hold the adjust for 3 sec to reset the trip.

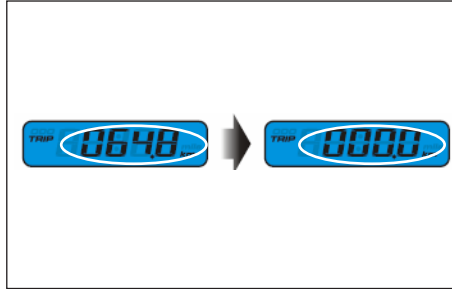

Watch screen

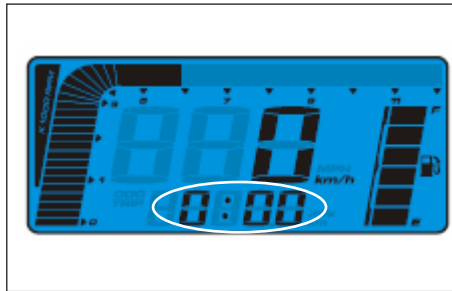

In clock screen press the adjust button once to switch from clock to the main screen.

Select button

Main screen

In main screen press and hold the select button for 3 sec to switch the backlight color.

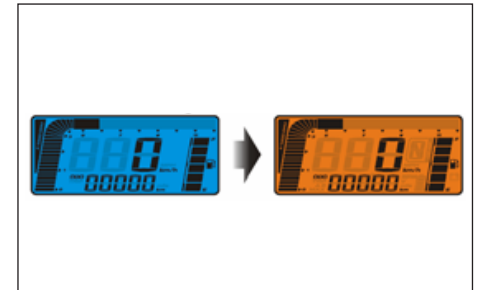

Watch-settings

In main screen press and hold the select and the adjust button for 3 sec to enter the clock settings.

INSTRUMENT AND CONTROL FUNCTIONS



Example: You want to set the hour to 14h press the adjust button to choose the hour you want to set.

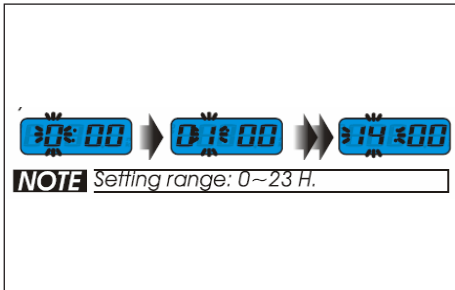

Example: You want to set the minute to 14:05 press the select button to enter the minute settings.

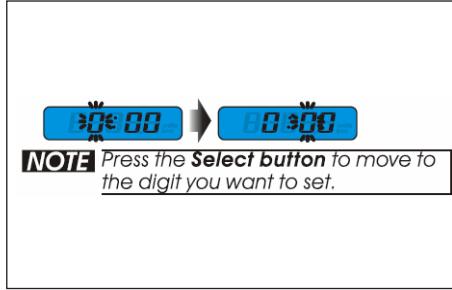

Then press the adjust button to choose the minute you want to set.



After the settings are done press the select button to store your settings and get back to the main screen.

HANDLEBAR SWITCHES - LEFT

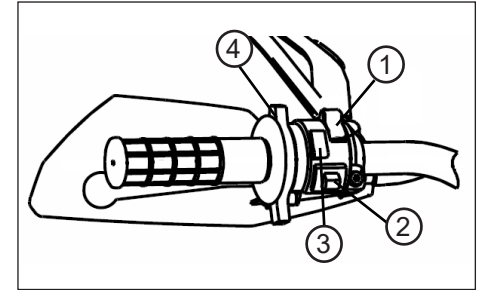

1. High/Low beam switch
2. Turn signal switch
3. Horn switch
4. Choke switch

High/Low beam switch
Set this switch to for the high beam and to for the low beam.

Turn signal switch
To signal a right-hand turn, push this switch to . To signal a left-hand turn, push this switch to . When released, the switch returns to the center position.

INSTRUMENT AND CONTROL FUNCTIONS

tion. To cancel the turn signal lights, push the switch in after it has returned to the center position.

Horn switch

Press this  switch to sound the horn.

Choke switch

The actuation of the lever facilitates the ignition and start of the vehicle when the engine is cold. Do not forget to give back the handle to the starting position after reaching the operating temperature.

HANDLEBAR SWITCHES - RIGHT

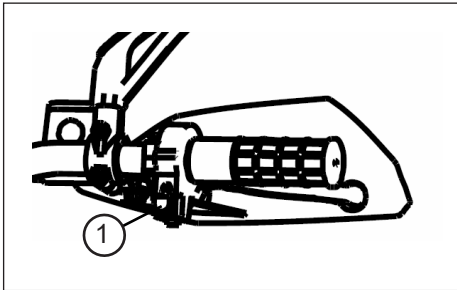

1. Starter switch

Starter switch

Pull the clutch lever in and press the electric starter switch  to start the vehicle.

CAUTION

At the same time you have to pull the brake lever to start the vehicle. For starting the vehicle read the notes in manual.

KICKSTARTER

The kickstarter (1) is located on the right side of the vehicle. It is used to start when the battery is empty or the electric starter would not work. The engine can only be started with the neutral gear is selected.

To start the engine with the kickstarter, move it down lightly with your foot until the gears engage, and then push it down smoothly but forcefully.

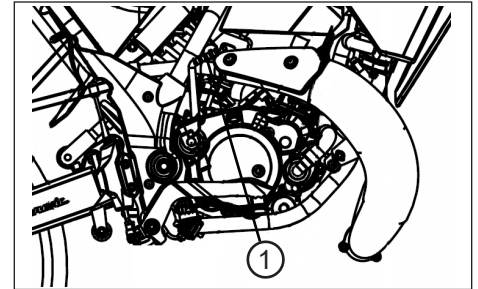

CAUTION

After starting the engine it is necessary to bring back the kickstarter to the starting position.

BRAKE LEVER

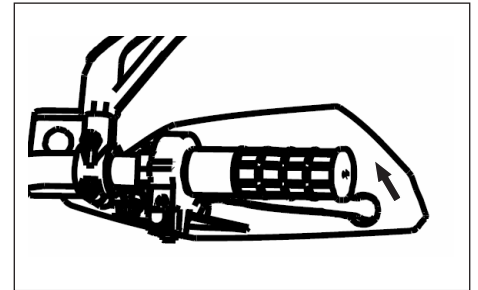

INSTRUMENT AND CONTROL FUNCTIONS

The brake lever is for the front brake is located in the right side of the handlebar. Pull back the lever to operate the brake.

BRAKE PEDAL

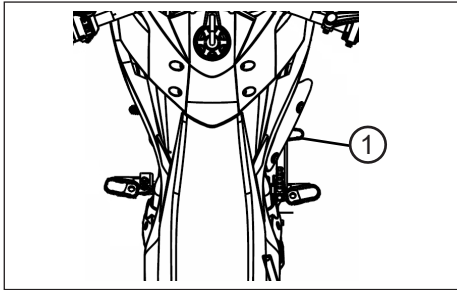

The brake pedal (1) is located on the right-hand side of the vehicle and operates the rear brake. Familiarise yourself with how it works before you ride the vehicle on public roads. Novices and returning riders are recommended to take a riding techniques course.

CLUTCH PEDAL

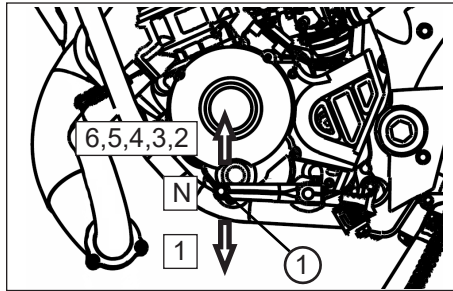

The clutch pedal (1) is located on the left side of the vehicle. The possible switching positions you see in the picture. The idle is between first and second gear.

CAUTION

Never attempt to change gear without releasing the clutch. Novices and returning riders are recommended to take a riding techniques course.

FUEL COCK

1. OFF

No petrol can flow from the fuel tank to the carburettor. Always turn the petrol tap to the OFF position as soon as you have parked the vehicle.

2. ON

Turn the petrol tap to this position before you attempt to start the vehicle. Petrol flows from the fuel tank to the carburettor.

3. RESERVE

Irregular vehicle behaviour is often caused by a lack of fuel. In this event, turn the petrol tap to the RES position.

INSTRUMENT AND CONTROL FUNCTIONS

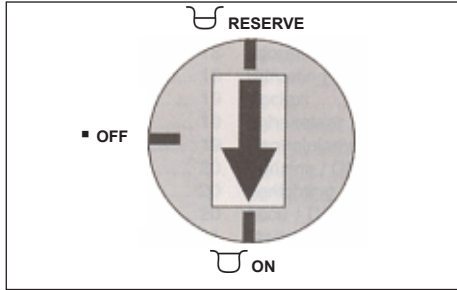

CAUTION

If you need switch to the RESERVE position, visit a filling station at the earliest opportunity to refuel.

FUEL TANK CAP

To open the fuel tank cap (1) you have to turn it counterclockwise. After refueling, you must turn it clockwise to close.

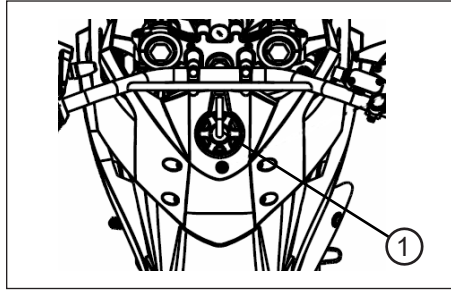

CAUTION

Make sure that the fuel tank cap is properly closed and locked before riding.

FUEL

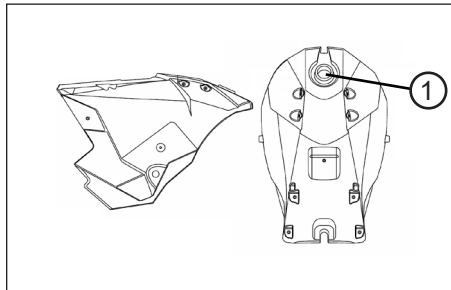

Make sure that there is sufficient fuel in the tank. Fill the fuel tank to the bottom of the filler tube as shown.

WARNING

- Do not overfill the fuel tank, otherwise it may overflow when the fuel warms up and expands.
- Avoid spilling fuel on the hot engine.

CAUTION

Immediately wipe off spilled fuel with a clean, dry, soft cloth, since fuel may damage the painted surfaces or plastic parts.

Regular unleaded gasoline only.
Recommended fuel: 95 oct
10 l +/- 0,2l



!!CAUTION!!
BIOETHANOL E10 IS NOT SUITABLE

INSTRUMENT AND CONTROL FUNCTIONS

OIL TANK CAP

The oil tank (1) is located under the fuel tank on front left side.

1. Remove the 2-stroke oil tank cap by unscrew it.
2. Top up the oil.
3. Install the 2-stroke oil tank cap by screw it into the oil tank opening.

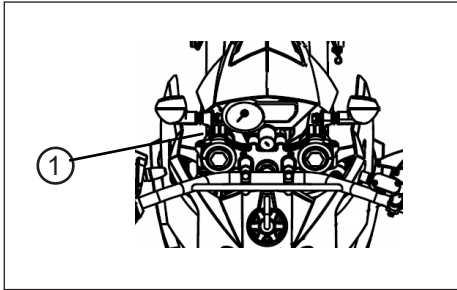

CAUTION

Make sure that the 2-stroke oil tank cap is properly installed before riding the vehicle.

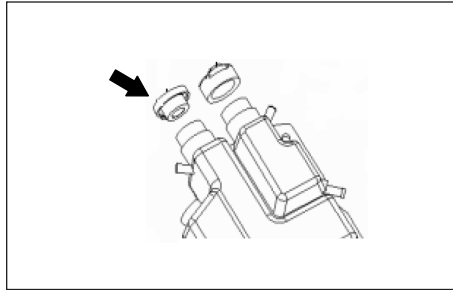

⚠ WARNING

At each refuelling you have to control the engine 2-stroke oil.
Capacity: 1 l

Recommendation:
Liqui Moly Motorbike 2T

RADIATOR AND COOLANT RESERVOIR

The radiator (2) is located under the fuel tank on the right front side.

The coolant reservoir (1) is located under the fuel tank on the front left side.

1. Remove cap by unscrew it.
2. Top up the coolant
3. Install the cap by screw it into.

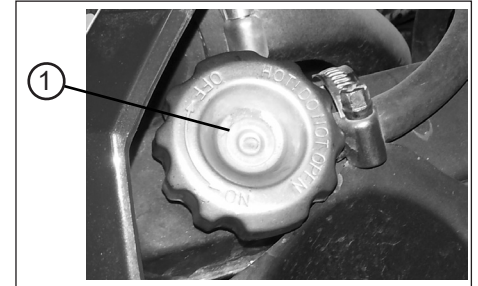
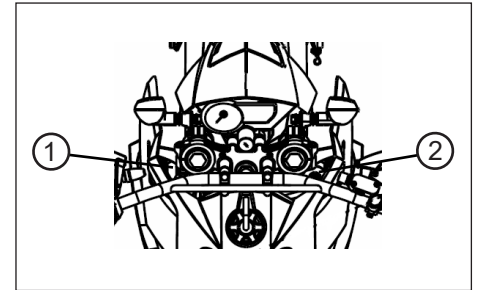

INSTRUMENT AND CONTROL FUNCTIONS

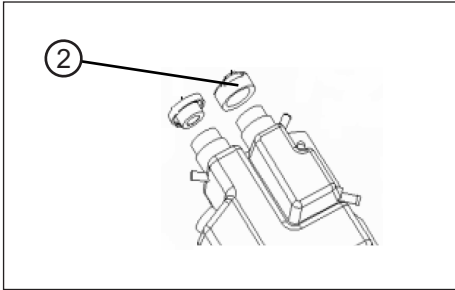

Capacity: 1 -1,5 l

CAUTION

Make sure that the cap is properly installed before riding the vehicle.

CATALYTIC CONVERTER

This model is equipped with a catalytic converter in the exhaust system.

⚠ WARNING

The exhaust system is hot after operation. Make sure that the exhaust system has cooled down before doing any maintenance work.

CAUTION

The following precautions must be observed to prevent a fire hazard or other damages.

- Use only unleaded gasoline. The use of leaded gasoline will cause unreparable damage to the catalytic converter.
- Never park the vehicle near possible fire hazards such as grass or other materials that easily burn.
- Do not allow the engine to idle too long.

SEAT

To open the seat (2)

1. Place the vehicle on the side stand.
2. Insert the key in the lock (1) which is located under seat on the left side
3. Turn the key about 1/4 turn clockwise.
4. The lock is unlocked and the seat opens and you can fold it up.

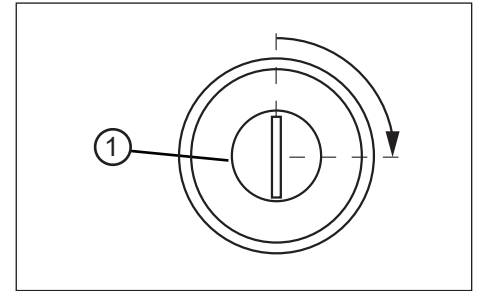

CAUTION

Do not push inward when turning the key.

INSTRUMENT AND CONTROL FUNCTIONS

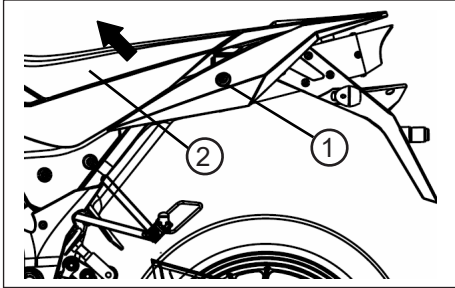

To close the seat (2)

Fold down the seat and press it directly over the lock with the palm of your hand into it.

CAUTION

- When you close the seat by force or strike, parts can be damaged.
- Make sure that the seat is locked before driving or when you park the vehicle.

OWNER'S TOOL KIT

The owner's tool kit is located in the tool box (1) under the seat and can be used for repairs.

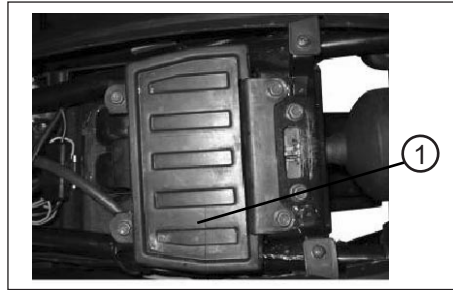

CAUTION

- Since the tool box will accumulate heat by the heat of sun and engine, please do not put anything that is sensitive to the heat.
- Do not put anything valuable or breakable objects in the storage luggage box.

SIDE STAND

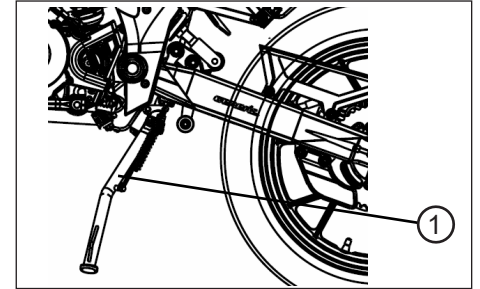

The side stand (1) is located on the left side of the Vehicle. Release the side-stand by using your feet to step on the bracket of side stand to up-right position to stand the vehicle.

CAUTION

- The side stand with auto-rebound system. Make sure your vehicle has been parked well and is stable enough to stand the vehicle.
- Please avoid using the side stand to park the vehicle on a slope, soft land or un-flat ground.

PRE-OPERATION CHECKS

The condition of a vehicle is the owner's responsibility. The operator should check the vehicle by simple but thorough inspection, to make sure of vehicle condition, quick inspect some key and important parts, to prevent the vehicle from serious consequence/accident. Please carefully check the following points before each ride.

CAUTION

Pre-operation checks should be made each time the vehicle is used. Such an inspection can be accomplished in a very short time; and the added safety it assures is more than worth the time involved.

WARNING

**If any item in the Pre-operation check list is not working properly , have it inspected and repaired before operating the vehicle. If failed to be corrected by yourself, please turn to repair shop immediately.
If failed to be corrected by yourself, please turn to repair shop immediately.**

PRE-OPERATION CHECKS

PRE-OPERATION CHECK LIST

CHECKPOINT	TO VERIFY
Fuel	<ul style="list-style-type: none"> • Check fuel level in fuel tank. • Refuel if necessary. • Check fuel line for leakage.
Engine oil	<ul style="list-style-type: none"> • Check oil level in oil tank. • If necessary, add recommended oil to specified level. • Check vehicle for oil leakage.
Final transmission oil	<ul style="list-style-type: none"> • Check vehicle for oil leakage.
Front brake	<ul style="list-style-type: none"> • Check operation. • If soft or spongy, have dealer bleed hydraulic system. • Check brake pads for wear. • Replace if necessary. • Check fluid level in reservoir. • If necessary, add recommended brake fluid to specified level. • Check hydraulic system for leakage.
Rear brake	<ul style="list-style-type: none"> • Check operation. • If soft or spongy, have dealer bleed hydraulic system. • Check brake pads for wear. • Replace if necessary. • Check fluid level in reservoir. • If necessary, add recommended brake fluid to specified level. • Check hydraulic system for leakage.
Throttle grip	<ul style="list-style-type: none"> • Make sure that operation is smooth. • Check cable free play. • If necessary, have dealer adjust cable free play and lubricate cable and grip housing.
Wheels and tires	<ul style="list-style-type: none"> • Check for damage. • Check tire condition and tread depth. • Check air pressure.
Brake levers	<ul style="list-style-type: none"> • Make sure that operation is smooth. • Lubricate lever pivoting points if necessary.
Side stand	<ul style="list-style-type: none"> • Make sure that operation is smooth. • Lubricate pivot if necessary.
Chassis fasteners	<ul style="list-style-type: none"> • Make sure that all nuts, bolts and screws are properly tightened. • Tighten if necessary.
Instruments, lights, signals and switches	<ul style="list-style-type: none"> • Check operation • Correct if necessary

OPERATION AND IMPORTANT RIDING POINTS

⚠ WARNING

- Before riding the vehicle, please make sure that you are fully familiar with all operating controls & their functions before riding. To consult a dealer shop if you not thoroughly understand.
- Please do not start the engine in a closed area, the exhaust air are poisonous, and inhaling them can cause loss of consciousness and even death in short time.



STARTING THE ENGINE

CAUTION

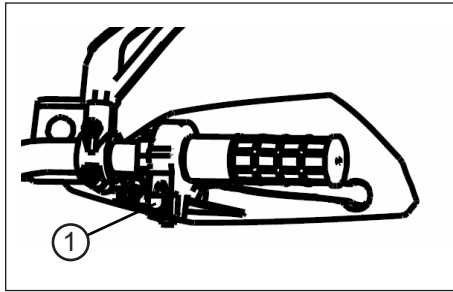
Note the point „Engine break in“ before you start to riding the vehicle.





Starting with the electric starter

1. Turn the fuel cock to the position  ON
2. Turn the key to ON .
3. Insert the neutral gear.
4. Pull the right brake lever otherwise the vehicle will not start.
5. Push the start switch button  (1) for a few seconds.

CAUTION

- When engine is cold set the choke on the close position, use the kickstarter or the electric starter to start the engine. Then set the choke on the midway position in order to warm the engine. At last set the choke on the open position, if the engine operates smoothly, it implies the warmed engine.
- When engine is warm do not use the choke system.
- Do not crank the engine more than 5 seconds on any one attempt.

Starting with the kickstarter

1. Turn the fuel cock to the position  ON
2. Turn the key to ON .
3. Insert the neutral gear.
4. Unfold the kickstart lever (1) and push with your foot down until you see a noticeable resistance.
5. Then kick the kickstarter evenly and powerfully downwards.

OPERATION AND IMPORTANT RIDING POINTS

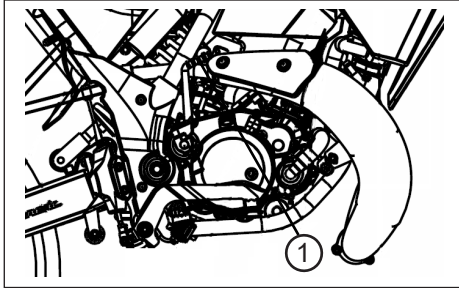

CAUTION

- The engine starts immediately upon actuation of the starter, then wait a few seconds before you try to start it again. Each starting process should be as short as possible in order to save battery and the starter.
- The vehicle must periodically (recommended weekly) start with the kick starter, otherwise the grease can gum up the kick starter gear and the kick starter not to operate. den Anlasser zu schonen.

CAUTION

Before driving allow the engine to warm up otherwise the spark plug and engine can be damaged early.

STARTING OFF

1. Pull the clutch lever
2. Shift the engine to the first gear
3. Slowly release the clutch lever and open the throttle at the same time.

SHIFTING AND RIDING

a) Shifting gears upwards

1. Release the throttle
2. Pull the clutch lever
3. Lift the gear lever upwards to change to the higher gears.
4. Slowly release the clutch lever and open the throttle at the same time.

b) Shifting gears downwards

1. Release the throttle
2. Operate the brakes and reduce the speed to a appropriate speed.
3. Pull the clutch lever
4. Lift the gear lever down wards to change to the lower gears.
5. Slowly release the clutch lever and open the throttle at the same time.

⚠ WARNING

Always switch one gear only, otherwise the transmission can be damaged.

ACCELERATION AND DECELERATION

The speed can be adjusted by opening and closing the throttle. To increase the speed, turn the throttle grip in direction (a). To reduce the speed, turn the throttle grip in direction (b).

OPERATION AND IMPORTANT RIDING POINTS

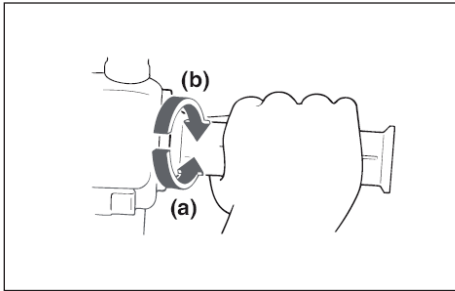

BRAKING

1. Release the throttle.
2. Apply the clutch lever gradually increasing the pressure.
3. Apply the front and rear brake at the same time.

⚠ WARNING

- Avoid hard or sudden braking (especially when cornering) otherwise the motorcycle may skid.
- Railroad crossings, street-car rails, iron plates on road construction sites, and manhole covers become extremely slippery when wet.

- Therefore slow down when approaching such areas and cross them with caution.

PARKING

1. Reduce the throttle to 0 position.
2. Pull the clutch lever
3. Switch the gear to N - neutral
4. Operate the brakes
5. After the vehicle is stopped turn off the ignition.
6. Lower the side stand with your foot while holding the motorcycle upright. Remove the key from the main switch.

⚠ WARNING

Since the engine and exhaust system can become very hot, park in a place where pedestrians or children are not likely to touch them.

Do not park on a slope or on soft ground, otherwise the vehicle may overturn.

STOP THE ENGINE

1. Reduce the throttle to 0 position.
2. Pull the clutch lever
3. Switch the gear to N - neutral
4. Operate the brakes
5. After the vehicle is stopped turn off the ignition.

ENGINE BREAK IN

During the first 1000 km do not ride the vehicle over 75% of its maximum speed. Avoid opening the accelerator completely and varies speed repeatedly over long distances. After the first 1000 km increase speed gradually until reaching maximum performance.

CAUTION

- The durability and the efficiency of your scooter depend strongly on the care received during the run-in period. The mechanisms of the mobile parts are mutually hardened and adapted.

OPERATION AND IMPORTANT RIDING POINTS

- After better run-in is obtained not by riding slowly but softly and carefully. During this period, it is advisable to ride the vehicle at $\frac{3}{4}$ of maximum performance. In the event that full acceleration is necessary (overtaking maneuvers, steep slopes, etc.) try to limit the time to a minimum.
- Gearbox oil must be changed once the first 1000 km are covered. Use the recommended oil type and specified quantity only.

The durability and the efficiency of your scooter depend strongly on the care received during the run-in period. The mechanisms of the mobile parts are mutually hardened and adapted.

After better run-in is obtained not by riding slowly but softly and carefully. During this period, it is advisable to ride the vehicle at $\frac{3}{4}$ of maximum performance. In the event that full acceleration is necessary (overtaking maneuvers, steep slopes, etc.) try to limit the time to a minimum.

Gearbox oil must be changed once the first 1000 km are covered. Use the recommended oil type and specified quantity only.

To obtain optimum adjustment of mobile parts, a long life and better performance, it is necessary not to force the vehicle during the 1000 km. The vehicle must have a suitable run-in period, during which the following precautions must be considered:

- After starting the engine, warm it up progressively, without maximum acceleration (we recommend not to exceed $\frac{3}{4}$ of the throttle grip opening for 1st gear) or overcharge.
- In long stretches, do not use full speed consistently and varies the speed repeatedly.
- When facing steep slopes, downshift to have better power.
- After a long run do not stop the engine suddenly, leave it running at minimum acceleration for some seconds.

- Check the non-existence of oil, fuel or brake liquid leaks.
- In case of anomalous noise, try to identify its cause immediately.

PERIODIC MAINTENANCE AND MINOR REPAIR

CAUTION

Most of the Safety and condition of vehicle depend on how you do the correct maintenance , periodic inspection, adjustment and lubrication. The following are contents that help the operator to do such skills on the following pages.

WARNING

Maintenance, replacement, or repair of the emission control devices and systems may be performed by any repair shop or individual that is certified and must follow the local law regulations.

If you are not familiar with maintenance work, have a dealer do it for you.

PERIODIC MAINTENANCE AND MINOR REPAIR

OWNER'S TOOL KIT

The service information included in this manual and the tools provided in the owner's tool kit are intended to assist you in the performance of preventive maintenance and minor repairs. However, additional tools such as a torque wrench may be necessary to perform certain maintenance work correctly.

CAUTION

If you do not have the tools or experience required for a particular job, have a dealer perform it for you.

⚠ WARNING

Modifications not approved by maker may cause loss of performance, excessive emissions, and render the vehicle unsafe for use. Consult a dealer before attempting any changes.

Modifications without authorization of the manufacturer cause void the warranty.

SPARK PLUG

The spark plug is an important engine component, which is easy to check. Since heat and deposits will cause any spark plug to slowly erode, the spark plug should be removed and checked in accordance with the periodic maintenance and lubrication chart. In addition, the condition of the spark plug can reveal the condition of the engine.

The spark plug (1) is on the left front of the vehicle.

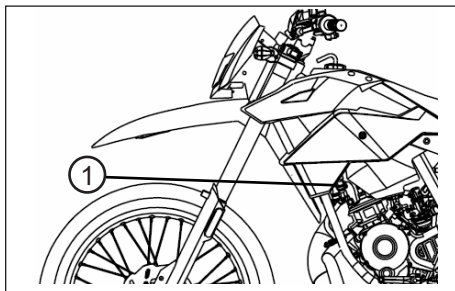

Remove the spark plug

1. Remove the spark plug cap
2. Remove the spark plug, with the spark plug wrench included in the owner's tool kit.
3. Check that the porcelain insulator (2) around the center electrode of the spark plug is a medium-to-light tan (the ideal color when the vehicle is ridden normally).

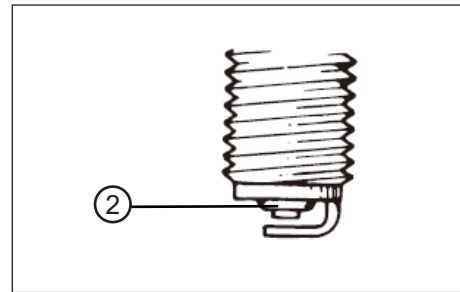

CAUTION

If the spark plug shows a distinctly different color, the engine could be operating improperly. Do not attempt to diagnose such problems yourself. Instead, have a dealer check the vehicle.

PERIODIC MAINTENANCE AND MINOR REPAIR

4. Check the spark plug for electrode (3) erosion and excessive carbon or other deposits, and replace it if necessary.

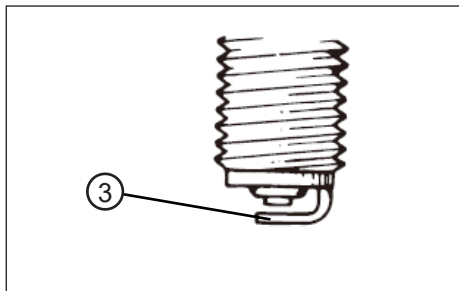

**Specified spark plug:
NGK BR8ES**

⚠ WARNING

Please note that no other spark plug model is allowed. Using a different spark plug model can immediately lead to engine damage.

5. Measure the spark plug gap with a wire thickness gauge and, if necessary, adjust the gap to specification. Clean the surface of the spark plug gasket and its mating surface, and then wipe off any grime from the spark plug threads.
6. Install the spark plug with the spark plug wrench, and then tighten it to the specified torque.

Spark plug gap: 0,6 - 0,7 mm

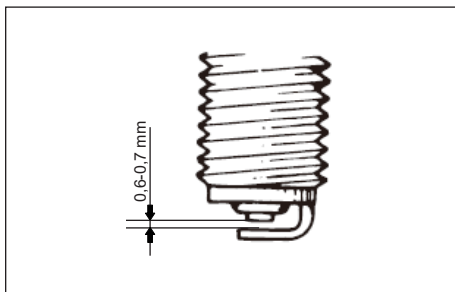

⚠ WARNING

Please note the max. torque when inserting the plug. If you do not have the ability to control you leave control of the spark plug to the dealer.

Tightening torque: 12 Nm

FINAL TRANSMISSION OIL

The final transmission case (1) must be checked for oil leakage before each ride. If any leakage is found, have a dealer check and repair the vehicle. In addition, the final transmission oil must be changed as follows at the intervals specified in the periodic maintenance and lubrication chart.

CAUTION

As long as the vehicle is within the warranty period the dealer is responsible to change the gear oil.

PERIODIC MAINTENANCE AND MINOR REPAIR

Change final transmission oil

1. Start the engine, warm up the final transmission oil by riding the vehicle for several minutes, and then stop the engine.
2. Place the vehicle on the main stand.
3. Place an oil pan under the final transmission case to collect the used oil.
4. Remove the oil filler cap (2) and drain bolt (3) to drain the oil from the final transmission case.

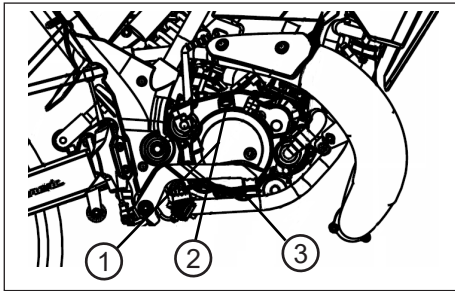

5. Install the final transmission oil drain bolt, and then tighten it to the specified torque.

Tightening torque: 18 Nm

6. Add the requested amount of the recommended final transmission oil, and then install and tighten the oil filler cap.

Recommended final transmission oil:
Liqui Moly SAE 10W-40
Oil quantity: Full: 0,5 l / Change: 0,4 l

⚠ WARNING

- Make sure that no foreign material enters the final transmission case.
 - Make sure that no oil gets on the tire or wheel.
7. Check the final transmission case for oil leakage. If oil is leaking, check for the cause.

COOLANT

Before you start operating the vehicle, check the coolant level. The radiator should be completely filled with coolant. The reservoir is located right in front of the tank fixed to the frame. In the expansion tank, the coolant should be between the MIN and MAX mark stand.

Recommended coolant:
Liqui Moly Coolant Ready Mix

CAUTION

The new filling and bleeding of the cooling system should be carried out by a dealer.

AIR FILTER

The air filter should be replaced according to the maintenance schedule. Replace the air filter more often if you drive in unusually wet or dusty areas.

PERIODIC MAINTENANCE AND MINOR REPAIR

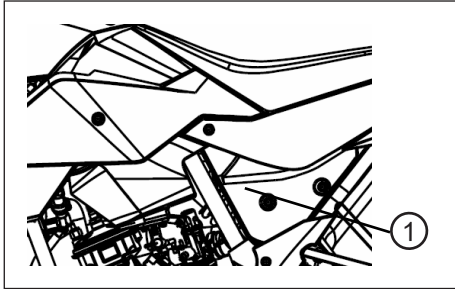

Replace the air filter

1. Remove the seat
2. Remove the side cover
3. Unscrew the screws of the air filter housing (1).
4. Pull the air filter out.
5. Replace the filter with a new one.
6. Coat the mating surfaces of the air filter case and air filter case cover lightly with grease for an airtight seal.
7. Install the air filter.
8. Mount the air filter housing.
9. Mount the side cover
10. Install the seat.

CAUTION

- Make sure that the air filter element is properly seated in the air filter case.
- The engine should never be operated without the air filter element installed, otherwise the piston and/or cylinder may become excessively worn.

CARBURETOR

The carburetor is an important part of the engine and its emission control system, which requires very sophisticated adjustment. Therefore, carburetor adjustments should be left to dealer, who has the necessary professional knowledge and experience.

IDLING SPEED

If the idle is not correct consult a dealer to check it.

The minimum speed of the engine (idling) must be approximately 1800 \pm 100 rev/min.

THROTTLE CABLE FREE PLAY

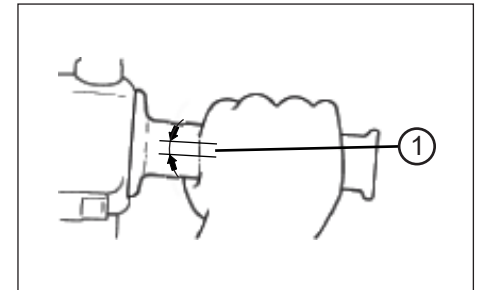

The throttle cable free play (1) should measure 1.5 ~ 3.5 mm at the throttle grip. Periodically check the throttle cable free play and, if necessary, have a dealer adjust it.

Throttle cable free play adjustment

1. Release the locknut (1)
2. Rotate the adjusting nut (2) to adjust the clearance.

PERIODIC MAINTENANCE AND MINOR REPAIR

3. Tighten the lock nut (1) after adjusting the nut (2).

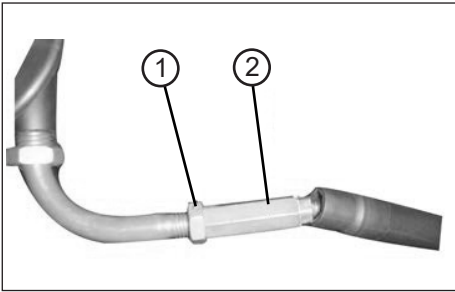

CLUTCH LEVER FREE PLAY

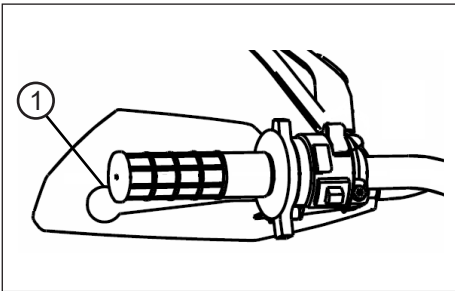

The clutch lever free play (1) should measure 1.0 ~ 2.0 mm. Periodically check the clutch lever free play and if necessary, have a dealer adjust it.

Clutch lever free play adjustment

1. Release the locknut (1)
2. Rotate the adjusting nut (2) to adjust the clearance.
3. Tighten the lock nut (1) after adjusting the nut (2).

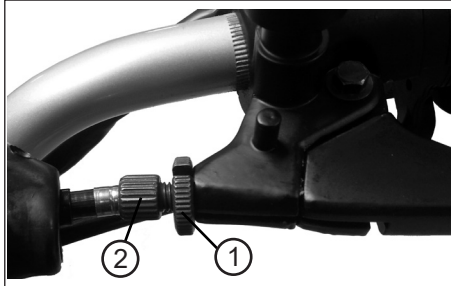

TIRES

To maximize the performance, durability, and safe operation of your vehicle, note the following points regarding the specified tires.

Tire air pressure

The tire air pressure should be checked and, if necessary, adjusted before each ride.

⚠ WARNING

The tire air pressure must be checked and adjusted on cold tires (i.e., when the temperature of the tires equals the ambient temperature).

The tire air pressure must be adjusted in accordance with the riding condition. If you are not familiar to this, please have dealer for help.

PERIODIC MAINTENANCE AND MINOR REPAIR

Tire air pressure:

Front: 2,1 bar - 2,5 bar

Rear: 2,1 bar - 2,5 bar

Total weight of rider, passenger,
cargo and accessories!

⚠ WARNING

Do not over load your vehicle, since it will increase pressure on the tire, braking, steering than original design, and may could cause damage or even lead to accident.

Allocation of your cargo and weight of your vehicle is very important for your own safety and vehicle performance. Load your cargo rmlly on vehicle and put the heaviest cargo to the center of vehicle, then distribute the weight evenly from side to side. It will keep you to have good steering after load.

Maximum load*: 150 kg

* Total weight of rider, passenger,
cargo and accessories

Tire inspection

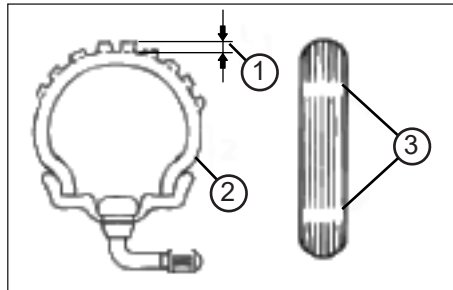

1. Tire tread depth
2. Tire sidewall
3. Tire wear indicator

⚠ WARNING

The tires must be checked before each ride.

If a tire tread shows crosswise lines (minimum tread depth), if the tire has a nail or glass fragments in it, or if the sidewall is cracked, have a dealer replace the tire immediately.

CAUTION

The tread depth may vary depending on country. Observe local regulations. The values listed here are technical values and may differ from the legal values of your region.

**Minimum tire tread depth:
Front and rear: > 1,6 mm**

⚠ WARNING

- Drive with worn tire is illegal, reduces stability and can lead to loss of control over the vehicle.
- Let worn or damaged tires replaced immediately by your dealer.
- Working tires and the dealer is responsible.
-

PERIODIC MAINTENANCE AND MINOR REPAIR

DIMENSIONS TIRE / RIMS SM model

Front: Rim: 17x2.5
Tire: 100/80-17

Rear: Rim: 17x3.0
Tire: 130/80-17

TYRE TYPE: tubeless

DIMENSIONS TIRES / RIMS X model

Front: Rim: 21x1.6
Tire: 3.00-21

Rear: Rim: 18x1.85
Tire: 4.10-18

TYRE TYPE: tubeless

RIMS

To maximize the performance, durability, and safe operation of your motorcycle, note the following points regarding the specified wheels.

- The wheel rims should be checked for cracks, bends or warpage before each ride. If any damage is found, have a dealer replace the wheel. Do not attempt even the smallest repair to the wheel. A deformed or cracked wheel must be replaced.
- The wheel should be balanced whenever either the tire or wheel has been changed or replaced. An unbalanced wheel can result in poor performance, adverse handling characteristics, and a shortened tire life.
- Ride at moderate speeds after changing a tire since the tire surface must first be “broken in” for it to develop its optimal characteristics.

BRAKE LEVER FREE PLAY / BRAKE PEDAL FREE PLAY

CAUTION

There should be no free play at the brake lever end. If there is free play, have a dealer inspect the brake system.

⚠ WARNING

A soft or spongy feeling in the brake lever can indicate the presence of air in the hydraulic system. If there is air in the hydraulic system, have a dealer bleed the system before operating the motorcycle. Air in the hydraulic system will diminish the braking performance, which may result in loss of control and an accident.

Rear brake

CAUTION

There should be no free play at the brake pedal's end. If there is free play, have a dealer inspect the brake system.

PERIODIC MAINTENANCE AND MINOR REPAIR

⚠ WARNING

A soft or spongy feeling in the brake pedal can indicate the presence of air in the hydraulic system. If there is air in the hydraulic system, have a dealer bleed the system before operating the motorcycle. Air in the hydraulic system will diminish the braking performance, which may result in loss of control and an accident.

Brake pedal free play

1. Loosen the locknut (1)
2. Turn the adjusting bolt (2) until the lever position is within specified position (10 mm free play on the lever)
3. Tighten the locknut again.

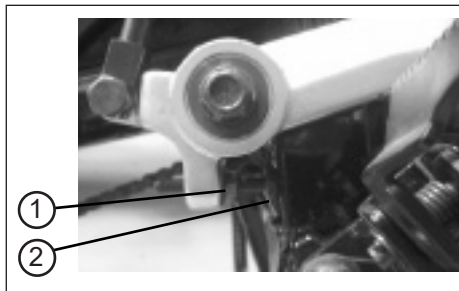

⚠ WARNING

If proper adjustment cannot be obtained as described contact a dealer to make this adjustment.

BRAKE PADS

The brake pads must be checked for wear at the intervals specified in the periodic maintenance and lubrication chart.

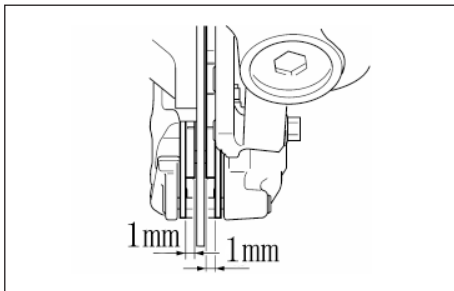

Each brake pad is provided with wear indicators, which allows you to check the brake pad wear without having to

disassemble the brake. To check the brake pad wear, check the position of the wear indicators while applying the brake. If a brake pad has worn to the point that a wear indicator almost touches the brake disc, have a dealer replace the brake pads as a set.

BRAKE FLUID

⚠ WARNING

Insufficient brake fluid may allow air to enter the brake system, possibly causing it to become ineffective. Before riding, check that the brake fluid is above the minimum level mark (1) and refill it if necessary.

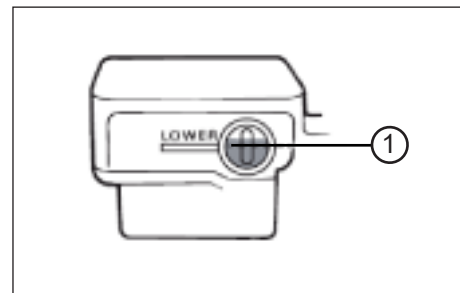

PERIODIC MAINTENANCE AND MINOR REPAIR

Low position brake fluid level may indicate worn brake pads and/or brake system leakage. If the brake fluid level is low, be sure to check the brake pads for wear and the brake system for leakage. When checking the fluid level, make sure that the top of the master cylinder is level by turning the handlebars. Use only the recommended quality brake fluid, otherwise the rubber seals may deteriorate, causing leakage and poor braking performance.

**Recommended brake fluid:
Liqui Moly Brake Fluid DOT 4**

- Refill with the same type of brake fluid. Mixing fluids may result in a harmful chemical reaction and lead to poor braking performance.
- Be careful that water does not enter the master cylinder when refilling. Water will significantly lower the boiling point of the fluid and may result in vapor lock.

- Brake fluid may deteriorate painted surfaces or plastic parts. Always clean up spilled fluid immediately.
- As the brake pads wear, it is normal for the brake fluid level to gradually go down. However, if the brake fluid level goes down suddenly, have a dealer check.

Changing the brake fluid

⚠ WARNING

Have a dealer change the brake fluid at the intervals specified in the NOTE after the periodic maintenance and lubrication chart.

CABLES

The operation of all control cables and the condition of the cables should be checked before each ride, and the cables and cable ends should be lubricated if necessary. If a cable is damaged or does not move smoothly, have a dealer check or replace it.

**Recommended lubricant:
Liqui Moly Motorbike Multispray**

⚠ WARNING

Damage to the outer housing of cables may result in internal rusting and cause interference with cable movement. Replace damaged cables as soon as possible to prevent unsafe conditions.

THROTTLE GRIP AND CABLE

The operation of the throttle grip should be checked before each ride. In addition, the cable should be lubricated at the intervals specified in the periodic maintenance chart.

LUBRICATING THE FRONT AND REAR BRAKE

The pivoting points of the front and rear brake must be lubricated at the inter-

PERIODIC MAINTENANCE AND MINOR REPAIR

vals specified in the periodic maintenance and lubrication chart.

**Recommended lubricant:
Liqui Moly Motorbike Multispray**

FRONT FORK

The condition and operation of the front fork must be checked as follows at the intervals specified in the periodic maintenance and lubrication chart.

**Recommended lubricant:
Liqui Moly Motorbike Multispray**

⚠ WARNING

Securely support the motorcycle so that there is no danger of it falling over.

1. Place the vehicle flat and upright from.

2. Check the inner tubes for scratches, damage and oil leakage.
3. Apply the front brake and push the handlebars several times down hard to verify the suspension of the fork.

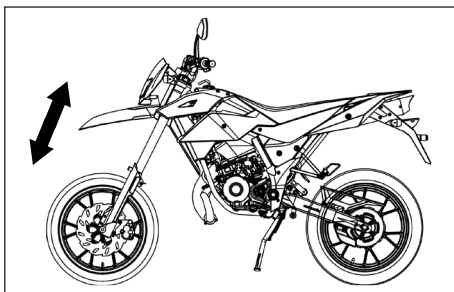

⚠ WARNING

- When damage to the fork, please contact your dealer.
- If you treat the telescopic fork with cleaning agents, make sure that they get no contact with the tires or the brakes. This can lead to dangerous accidents.

STEERING

⚠ WARNING

Worn or loose steering bearings may cause danger. Therefore, the operation of the steering must be checked as follows at the intervals specified in the periodic maintenance and lubrication chart.

1. Place the vehicle on the side stand/suitable motorcycle stand to raise the front wheel off the ground.
2. Hold the lower ends of the front fork legs and try to move them forward and backward.
3. If any free play can be felt, have a dealer check or repair the steering.

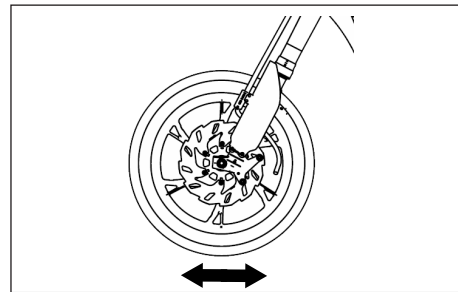

PERIODIC MAINTENANCE AND MINOR REPAIR

WHEEL BEARINGS

The front and rear wheel bearings must be checked at the intervals specified in the periodic maintenance and lubrication chart.

CAUTION

If there is play in the wheel hub or if the wheel does not turn smoothly, have a dealer check the wheel bearings.

DRIVE CHAIN

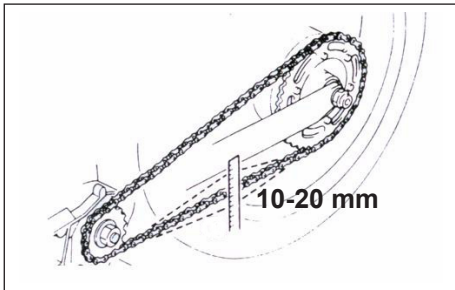

If the chain tension is too great, parts within the secondary power transmission (chain, chain sprockets transmission and rear wheel bearings) will be subjected to unnecessary stress resulting in early wear and even chain breakage. Too much slack in the chain, on the other hand, can result chain jumping off the chain wheels. If this happens the chain could also block the rear wheel or damage the engine. In either case the operator is likely to lose control of the vehicle.

Tensioning the chain drive

1. Loosen collar nut (1)
2. Loosen counter nut (2)
3. Turn right and left adjusting screws (3) equally far. The drive chain free play should be between 10 mm and 20 mm.
4. Tighten counter nut (2) and the collar nut (1).

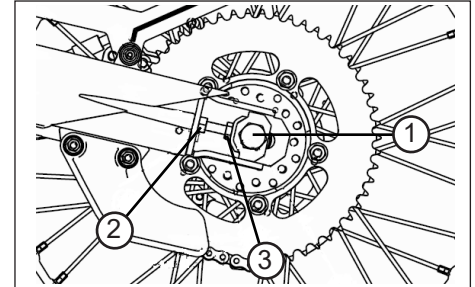

**Tightening torque of the collar nut
(1): 70 Nm**

SHOCK ABSORBER

Press the rear of the vehicle down to test the function of the rear damper. Make sure that no pressure is exerted on the exhaust in order not to damage it.

The shock absorber can be adjusted to suit the weight of the driver and the load.

PERIODIC MAINTENANCE AND MINOR REPAIR

Adjust the shock absorber

Use the nuts (1) and (2) to adjust the rear shock. Loosen the locknut (1) and adjust with the help of the nut (2) to adjust the preload of the shock absorber. Secure the damper then again with the locknut (1).

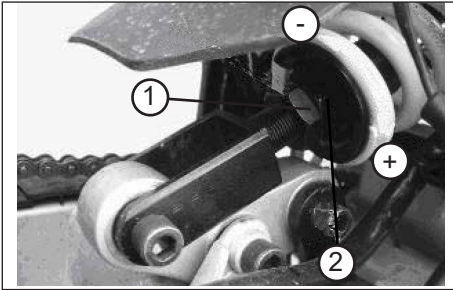

BATTERY

This model is equipped with a sealed-type (MF) battery, which does not require any maintenance. There is no need to check the electrolyte or to add distilled water.

⚠ WARNING

- Do not remove the battery vent seal, this can be dangerous, the battery permanently damaged.
- Battery acid is poisonous and dangerous, it contains sulfuric acid and leads to dangerous burns.
- Avoid skin, eye and clothing contact. Protect your eyes always when working near the battery.
- Upon contact with the battery acid, make immediate FIRST AID.
- If skin or eye contact with battery acid, rinse the affected areas with plenty of water.
- When accidentally swallowed battery acid drink large amounts of water.
- In both cases, as soon as possible, see a doctor.
- Batteries develop explosive hydrogen gas. Keep open flames, smoking materials away from the battery and make sure there is adequate ventilation when you charge a battery indoors.

- **KEEP THIS AND ALL BATTERIES OUT OF THE REACH OF CHILDREN.**

To charge the battery

Have a dealer charge the battery as soon as possible if it seems to have discharged. Keep in mind that the battery tends to discharge more quickly if the vehicle is equipped with optional electrical accessories.

To store the battery

- If the vehicle will not be used for more than one month, remove the battery, fully charge it, and then place it in a cool, dry place.
- If the battery will be stored for more than two months, check it at least once a month and fully charge it if necessary.
- Fully charge the battery before installation.
- After installation, make sure that the battery leads are properly connected to the battery terminals.

PERIODIC MAINTENANCE AND MINOR REPAIR

⚠ WARNING

Please contact your dealer if you are not familiar with handling the battery.

CAUTION

Always keep the battery charged. Storing a discharged battery can cause permanent battery damage.

FUSE

The fuse holder is located beside battery.

Replacing the fuse

1. Turn the key to  and turn off all electrical circuits.
2. Remove the blown fuse, and then install a new fuse of the specified amperage.

**Specified fuse:
10 Amp**

⚠ WARNING

Do not use a fuse of a higher amperage rating than recommended to avoid causing extensive damage to the electrical system and possibly a fire.

3. Turn the key to  and turn on the electrical circuits to check if the devices operate.
4. If the fuse immediately blows again, have a dealer check the electrical system.

LIGHTING - OPTION 1

Headlight bulbs

1. If the headlight bulb does not glow, switch off all consumers and switch off the engine.
2. Remove the bolts on the left and right side of the headlight (1).
3. Remove the headlight (2).

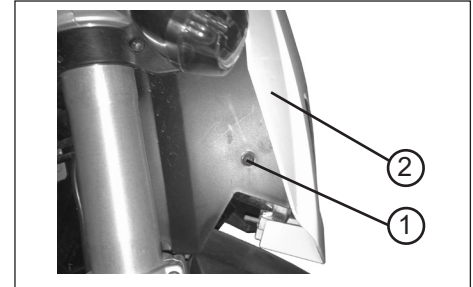

4. Take out the rubber dust cover (3).
5. Turn the fixing disc anti-clockwise to take out the the blup (4).

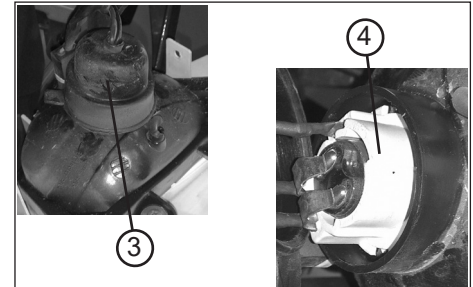

PERIODIC MAINTENANCE AND MINOR REPAIR

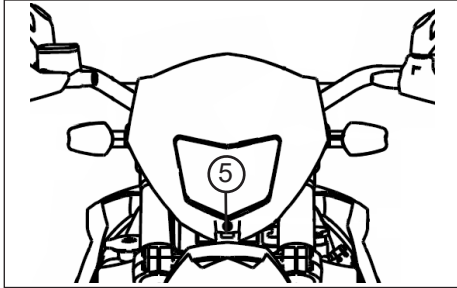

When you need to adjust the headlight turn in or turn out the adjusting screw (5).

Front turn signal light

If the turn signal light bulb does not come on, remove the screw of the indicator lens (1) out and replace the bulb.

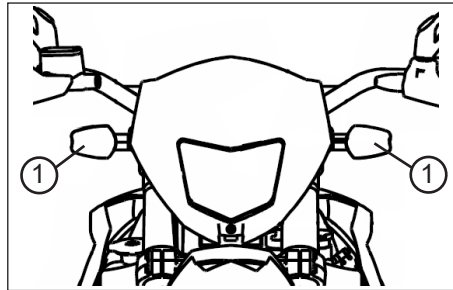

Rear turn signal light

If the turn signal light bulb does not come on, remove the screw of the indicator lens (1) out and replace the bulb.

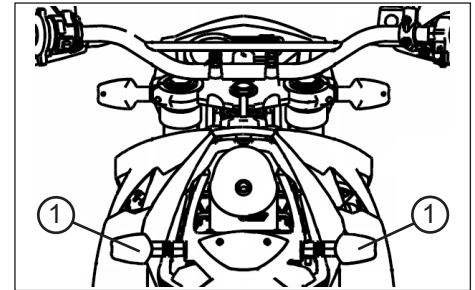

PERIODIC MAINTENANCE AND MINOR REPAIR

Taillight / Brake light and license plate lamp

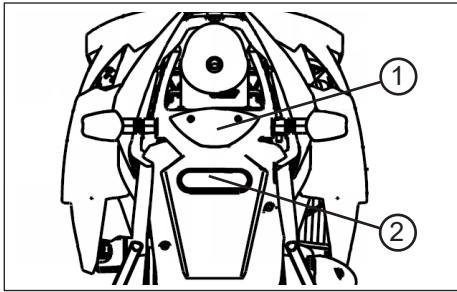

If the tail/brake light (1) or the license plate light (2) do not glow disassemble the bolts for changing the bulb.

LIGHTING - OPTION 2

Headlight bulbs

1. If the headlight bulb does not glow remove the bolts and screws (1 to 4) to disassemble the head light assembly.
2. Take out the rubber dust cover (5) and the plug (6).

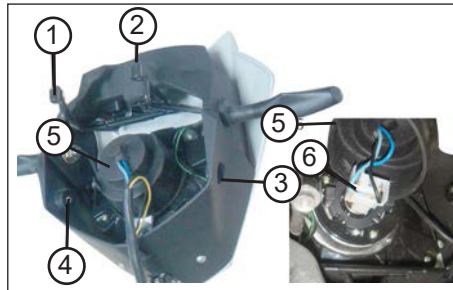

3. Turn the fixing disc anti-clockwise to take out the the blup (7).

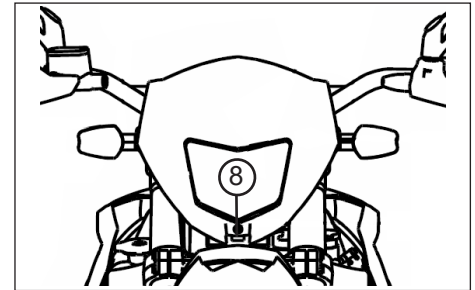
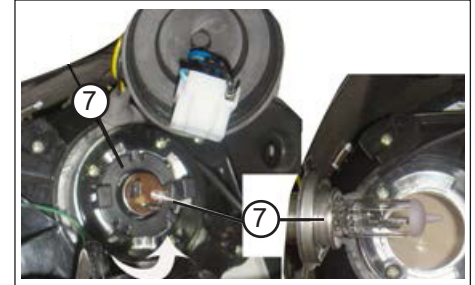

When you need to adjust the headlight turn in or turn out the adjusting screw (8).

PERIODIC MAINTENANCE AND MINOR REPAIR

Front turn signal light

If the turn signal light bulb (1) does not come on, please contact your dealer to replace it.

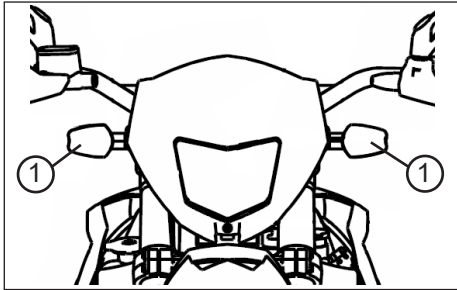

Rear turn signal light

If the turn signal light bulb (1) does not come on, please contact your dealer to replace it.

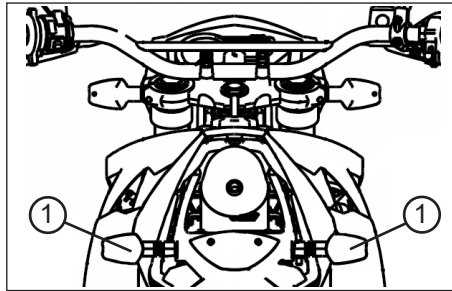

Taillight / Brake light and license plate lamp

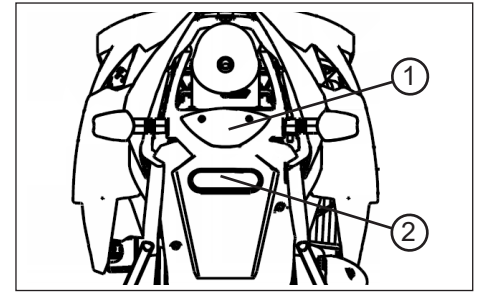

If the tail/brake light (1) or the license plate light (2) do not glow disassemble the bolts for changing the bulb.

TROUBLESHOOTING

Although the vehicles receive a thorough inspection before shipment from the factory, trouble may occur during operation. Any problem in the fuel, compression, or ignition systems, for example, can cause poor starting and loss of power.

The following troubleshooting chart represents a quick and easy procedure for checking these vital systems yourself. However, should your vehicle require any repair, take it to a dealer, whose skilled technicians have the necessary tools, experience, and knowhow to service the vehicle properly.

Use only genuine replacement parts. Imitation parts may look like parts, but they are often inferior have a shorter service life and can lead to expensive repair bills.

TROUBLESHOOTING

TROUBLESHOOTING CHART

⚠️ WARNING

Keep away open flames and do not smoke while checking or working on the fuel system.

1. Fuel

Check the fuel level in the fuel tank.

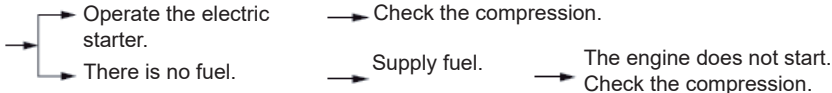

2. Compression

Operate the electric starter.

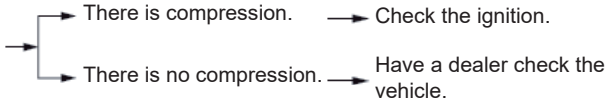

3. Ignition

Remove the spark plug and check the electrodes.

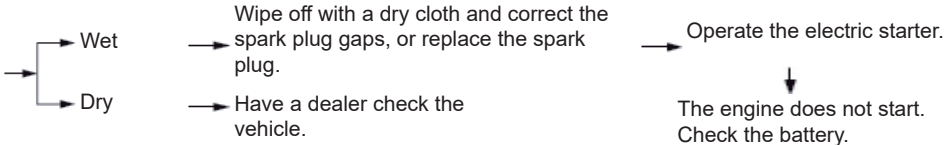

4. Battery

Operate the electric starter.

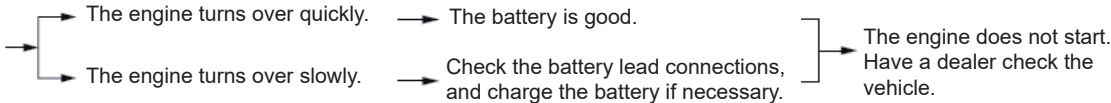

CLEAN AND STORAGE

CLEAN THE VEHICLE

Clean of the vehicle in proper and suitable way will make it attractive, extend it's life and optimize the performance.

Before cleaning

1. Cover the muffler outlet with a plastic bag to prevent water to come inside. Please do it only after the
2. Closed every caps, covers, electrical connectors that are well install and water can be avoid to get into, while you do the clean job.

CAUTION

- Do not use acid-based cleaners. If such funds used for stubborn stains, so use this only occasionally, dry it immediately after and then apply a corrosion protection spray.
- Always follow the manufacturer's instructions on care and cleaning agents.
- Use best only water and mild detergent or special cleaner from the dealer to the sensitive components

of the vehicle to prevent damage. Dry the plastic parts then wipe with a soft, dry cloth or sponge.

- Protect particularly plastic parts, paint, headlight glass from harsh chemicals such as fuel, rust remover, brake cleaner or similar. The use of such agents may result in malfunction, damage and affect the security itself.
- Do not use a high pressure washer or steam cleaner, causing water in storage can penetrate electrical components such as connectors or switches, lighting, ventilation hoses, brake shoes and brake linings or damage, seals, paint and other surfaces.

Cleaning after normal use

Remove dirt with warm water, a mild detergent, and a soft, clean sponge, and then rinse thoroughly with clean water. Use a toothbrush or bottlebrush for hard-to-reach areas.

Cleaning after riding in the rain, near the sea or on salt-sprayed roads

CAUTION

Since sea salt or salt sprayed on the roads during winter are extremely corrosive in combination with water, carry out the following steps after each ride.

- Wait until the engine / exhaust have cooled.
- Clean the vehicle with warm water and a mild detergent.
- Do not use hot water, which increases the corrosive effect of the salt.
- Apply a corrosion protection spray on all metal, including chrome- and nickel-plated, surfaces to prevent corrosion.

After cleaning

- Dry the vehicle.
- To prevent rust, we recommend appropriate care to use according to manufacturer's instructions.
- Wax all painted surfaces.

CLEAN AND STORAGE

Recommended Liqui Moly care products:

Motorbike Cleaner
Motorbike Chain Lube
Motorbike Multispray

WARNING

- Make sure that there is no oil or wax on the brakes or tires.
- If necessary, clean the brake discs and brake linings with a regular brake disc cleaner and wash the tires with warm water and a mild detergent.
- Before operating the vehicle, test the braking performance and tires.

STORAGE

Short-term (for a few days)

- Always store your vehicle in a cool, dry place and, if necessary, protect it against dust with a vehicle cover.

WARNING

Please store the vehicle in a well air flow room with dry air if possible. A place with wet humidity will cause rust.

Long-term (for weeks)

- Clean the vehicle.
- Drain the fuel from the carburetor.
- Enter the drained fuel back into the fuel tank.
- Fill the fuel tank to completely or add if necessary a fuel stabilizer to protect the fuel tank from rusting and the fuel from degradation.

Follow the steps below to cylinders, piston rings, etc. to prevent rusting.

- Remove spark plug cap and the spark plug.
- Give a teaspoon of engine oil into the spark plug hole.
- Join the Kickstarter to slow down and let the engine several times slowly rotate (thus the cylinder is oiled).
- Put the spark plug back in and put on the spark plug cap.

WARNING

To prevent damage or injury from sparking, make sure to ground the spark plug electrodes while turning the engine over.

- Lubricate all control cables and the pivoting points of all levers and pedals as well as of the side stand/main stand.
- Check and, if necessary, correct the tire air pressure, and then lift the vehicle so that both of its wheels are off the ground. Alternatively, turn the wheels a little every month in order to prevent the tires from becoming degraded in one spot.
- Cover the muffler outlet with a plastic bag to prevent moisture from entering it.
- Remove the battery and fully charge it. Store it in a cool, dry place and charge it once a month. Do not store the battery in an excessively cold or warm place [less than 0 °C (30 °F) or more than 30°C (90 °F)].

SPECIFICATIONS

DIMENSIONS - SM MODEL

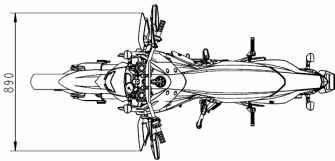
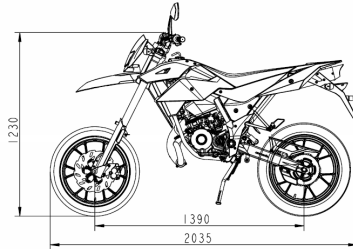

DIMENSIONS - X MODEL

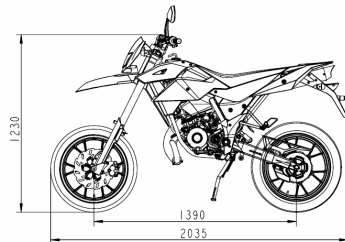

ENGINE

Engine type
2-stroke liquid cooled
Cylinder arrangement
Forward-inclined single cylinder
Displacement
49,6 cm³
Compression ratio
7,0:1
Starting system
Electric starter and kickstarter
Lubrication system
Separate lubrication
2-stroke engine oil

ENGINE OIL

Quantity 1 l
recommended type:
Liqui Moly Motorbike 2T

TRANSMISSION OIL

Type SAE 10W-40
recommended type:
Liqui Moly Motorbike 4T

AIR FILTER

Sponge

FUEL

Unleaded gasoline only 95 Oct
Capacity
10 +/- 0,2 l

CAUTION

**!! BIOETHANOL FUEL -
E10 IS NOT PERMITTED !!**

CARBURETOR

Manufacturer
DELLORTO

SPARK PLUG

Manufacturer / model
NGK / BR8ES
Spark plug gap
0,6-0,7 mm

CLUTCH

Clutch type
Multiple plate clutch
Transmission type
6-speed constant mesh transmission

CHASSIS

Frame type
Steel tube backbone

FRONT TIRE - SM MODEL

Rim: 17x2.5
Tyre: 100/80-17

REAR TIRE - SM MODEL

Rim: 17x3.0
Tyre: 130/80-17

FRONT TIRE - X MODEL

Rim: 21x1,6
Tyre: 3.00-21

REAR TIRE - X MODEL

Rim: 18x1,85
Tyre: 4.10-18

E5

SPECIFICATIONS

TIRE AIR PRESSURE (COLD TIRES)

Front: 2,1 bar - 2,5 bar

Rear: 2,1 bar - 2,5 bar

The selected tire pressure depends on the load!

FRONT BRAKE - SM MODEL

Type

Single Hydraulic disc brake

230 mm

Operation

Right hand

REAR BRAKE - X MODEL

Type

Single Hydraulic disc brake

280 mm

Operation

Right hand

REAR BRAKE

Type

Single Hydraulic disc brake

220 mm

Operation

Right food

RECOMMENDED FLUID

DOT 4 - Liqui Moly Brake Fluid

FRONT SUSPENSION

Type

Telescopic fork

Spring/shock absorber type

Coil spring/oil damper

REAR SUSPENSION

Type

Unit swing

Spring/shock absorber type

Gas/oil damper

ELECTRICAL SYSTEM

Ignition system

CDI

Charging system

CDI magneto

BATTERY

Model

YT4L-BS

Voltage, capacity

12 V, 3 Ah

HEADLIGHT

Halogen bulb

BULB VOLTAGE, WATTAGE X QUANTITY

Headlight

12 V, 35 W/35 W

Tail/brake light

12 V, 5 W/21 W

Front turn signal light

12 V, 10 W or LED

Rear turn signal light

12 V, 10 W or LED

License plate light

12 V, 5 W

Meter lighting

12 V, 2 W

High beam indicator light

12 V, 2 W

Engine oil indicator

12 V, 3 W

Turn signal indicator light

12 V, 3 W

FUSE

Main fuse

10 A

WARRANTY INFORMATION

Please carefully read the instruction manual of your vehicle before operating it in order to make yourself familiar with its handling. We explicitly point out that the instruction, maintenance, and care instructions given in the operating manual have to be complied with in order to sustain your claim towards warranty. Only the strict compliance with customer specifications stated in the instruction manual ensures the prolonging of the natural life of your vehicle. Starting with the date of the invoice a limited warranty of 24 months is granted regarding the accuracy of the vehicle in terms of material and manufacturing according to latest standards. The legal warranty regulations will not be restricted by this limited guarantee. Maintenance work has to be exclusively done by authorized workshops entitled by us. Warranty in general is bound to the region of invoicing and can therefore only be carried out within the country the vehicle was bought. Damages that can be traced back to inappropriate usage, manipulation, or neglecting of the maintenance/care/operating instructions will not be covered by warranty. Warranty can only be granted if occurring damages are immediately being reported to the seller or any other authorized workshop by the buyer. The warranty claim entitles the buyer to remedy deficiencies or to the reparation respectively the exchange of a damaged part in an authorized workshop after our approval. Compensation for remote or instantaneous damages cannot be granted. Vehicles in desolate condition will not be covered by warranty. Repair works carried out on warranty do not enlarge the guarantee period. Only this document entitles you to call on warranty services. Therefore please make sure that you are delivered this fully filled in document by the seller and that he has registered your vehicle correctly in our system. Please also mind the following advices.

Body and panelling of the vehicle have to be kept free of dirt constantly. Do not use high pressure water blasters, strong jets of water, sharp and corrosive or other aggressive detergents which could harm surfaces and varnish permanently and foster corrosion. It is vital to use protecting cleansers. Please consult our dealers for the right and appropriate products. Aluminium parts or other refined parts (chrome parts, anodized parts or other processed surfaces) have to be treated with appropriate maintenance products in order to prevent oxidation. Frame and metal parts are continuously to be treated with anticorrosive. A vehicle constantly parked outside has to be covered to avoid weathering and crack formations on seat and plastic parts. Vehicles used off-road and for racing purposes are excluded from warranty.

Material which is to be used in the context of service and maintenance works are excluded from warranty as well as the following parts: incandescent bulbs, brake pads, clutch lining, filter elements, spark plugs, drive sprocket, wheel and axle., as well as the tires.

MAINTENANCE SCHEDULE

The guarantee can be granted only if the vehicle has been serviced in accordance with this maintenance schedule.

The inspection intervals are required, otherwise, no guarantee can be granted.		1000 km	4.000 km or 1. year	7.000 km or 2. year	10.000 km or 3. year	13.000 km or 4. year
PART	TO DO					
Air filter	Clean / exchange	√	√	exchange	√	√
Wheels, rims	Control	√	√	√	√	√
Tires	Control / tire pressure		√	√	√	√
Wheel bearing	Control / exchange		√	√	√	√
Steering bearing	Control / clean / lubricate	√	√	√	lubricate	√
Screws Coverparts	Control / tighten		√	√	√	√
Brake system	Control / clean / exchange		√	√	√	√
Main stand	Control / clean / lubricate		√	√	√	√
Front fork	Control		√	√	√	√
Rear suspension	Control		√	√	√	√
Oil filter	Clean	√		√		√
Engine oil	Control / exchange	exchange	√	exchange	√	exchange
Valves (Engine)	Control / adjust	√	√	√	√	√
Transmission oil*	Exchange	exchange		exchange		exchange
Variomatic belt*	Control / exchange		√	exchange	√	
Fly wheels*	Control / exchange		√	exchange	√	
Driven chain / sprokets*	Control / clean / exchange	√	√	√	√	√
Clutch	Control	√	√	√	√	√
Cable / bowden	Control / clean / lubricate	√	√	√	√	√
Throttle	Control / adjust / lubricate		√	√	√	√
Lights / switches	Control / adjust	√	√	√	√	√
Fuel line / fuel filter	Control / exchange		√	exchange	√	√
Idle speed	Control / adjust	√	√	√	√	√
Exhaust system	Control / tighten		√	√	√	√
Coolant*	Control	√	√	√	√	√

CAUTION: Variomatic belt, fly wheels respectively drive chain/sproket, spark pluge, fuel filter and air filter element have to be exchanged every 7000km. Only use duration coolant. Brake lines have to be exchanged at least every 4 years. From 13.000km or 24th month the inspection should be made every 7000km. The vehicle is constantly checked for rust. The owner is responsible for rust prevention.

* Model specific deviations are possible

SPACE FOR NOTES

Recommended:



Copyright © 2018

All rights reserved.

This user manual is copyrighted.

Copying in mechanical, electronic or any other form without the written permission of the manufacturer is prohibited.

Distributed by:

KSR Group GmbH

Im Wirtschaftspark 15

3494 Gedersdorf

Austria

The copyright is owned by the Company / Manufacturer:

KSR Group GmbH

Im Wirtschaftspark 15

3494 Gedersdorf

Austria

Product and specifications are subject to change without notice.